

000 (

016)



# *Gavrosh 10*

Ламповый гитарный комбо-усилитель



**YERASOV®**

1.	.....	1
2.	.....	2
	.....	2
	.....	3
-	.....	4-5
3.	.....	6
4.	.....	6
5.	.....	7
6.	.....	7
7.	.....	8
8.	.....	9

1.

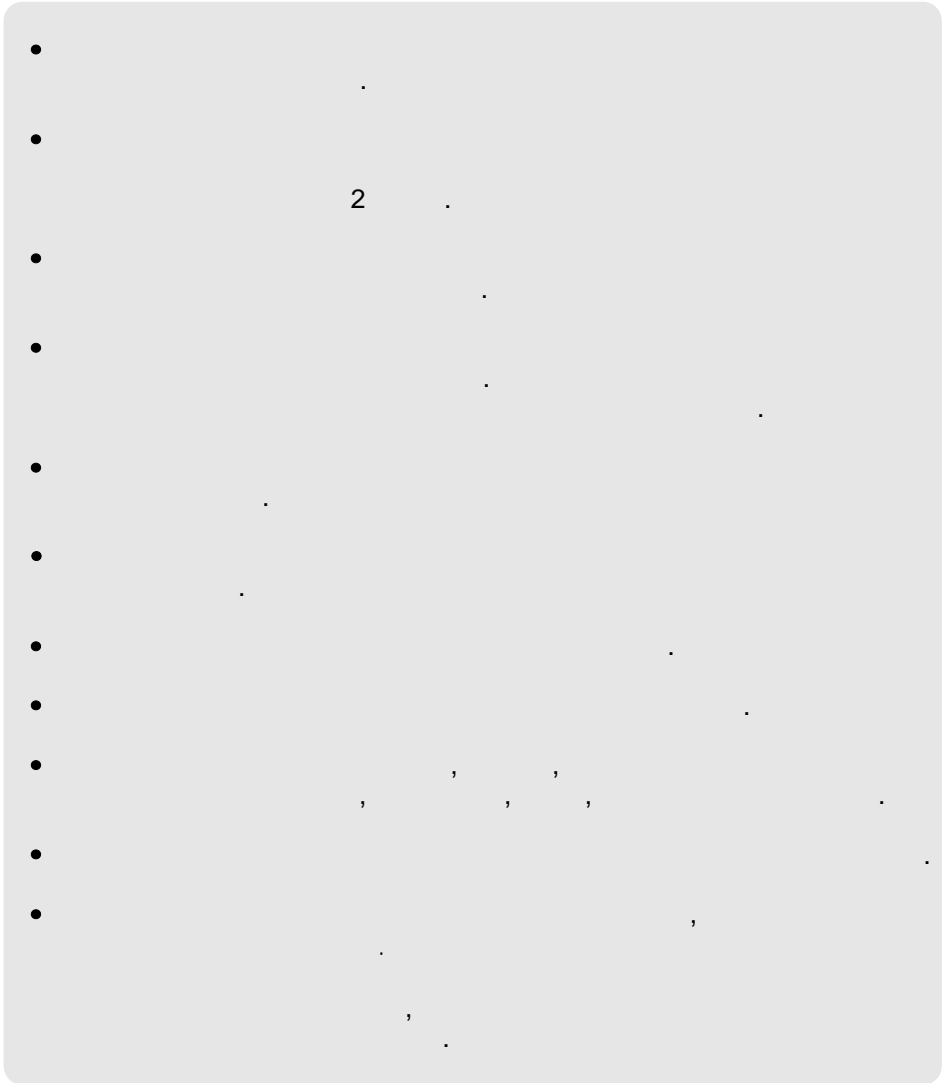

# YERASOV®

2.

Gavrosh 10- 2- -  
 CLEAN VOLUME, LEAD  
 GAIN, VOLUME LOW/HIGH,  
 Clean/Lead,  
 FOOTSWITCH. BASS,  
 MIDDLE, TREBLE.  
 PRESENCE.  
 CD IN  
 SEND/RETURN,  
 2  
 2/10 W,  
 8  
 4 12",  
 " "  
 SPEAKER

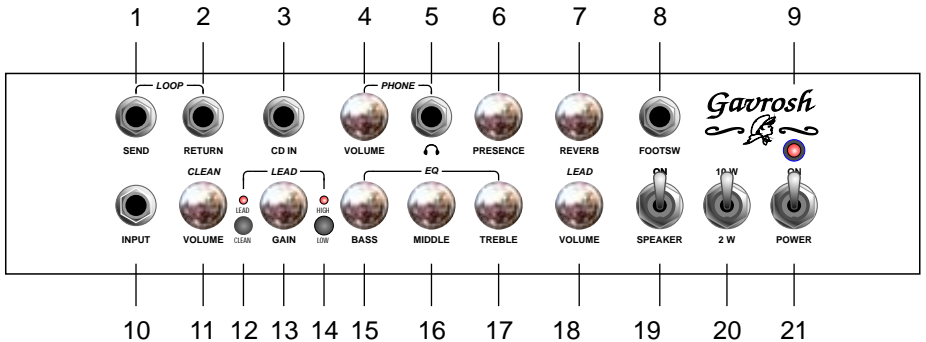

1 - SEND -  
 2 - RETURN -

3 - CD IN -  
 4 - VOLUME -  
 5 -  
 6 - PRESENCE -

- 7 - REVERB -
- 8 - FOOTSW-
- 9 -
- 10 - INPUT -
- 11- VOLUME - CLEAN
- 12 - CLEAN / LEAD
- 13 - GAIN -
- 14 - LOW / HIGH LEAD
- 15 - BASS -
- 16 - MIDDLE -
- 17 - TREBLE -
- 18 - VOLUME - LEAD
- 19 - SPEAKER -
- 20 - 10W/2W -
- 21 - POWER -

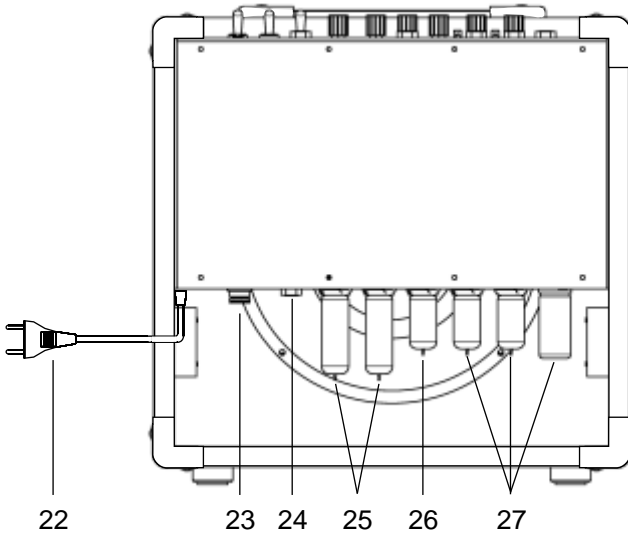

- 22 -
- 23 -
- 24 -
- 25 -
- 26 -
- 27 -

8

2xEL84  
 12AT7/ECC81  
 3x12AX7/ECC83

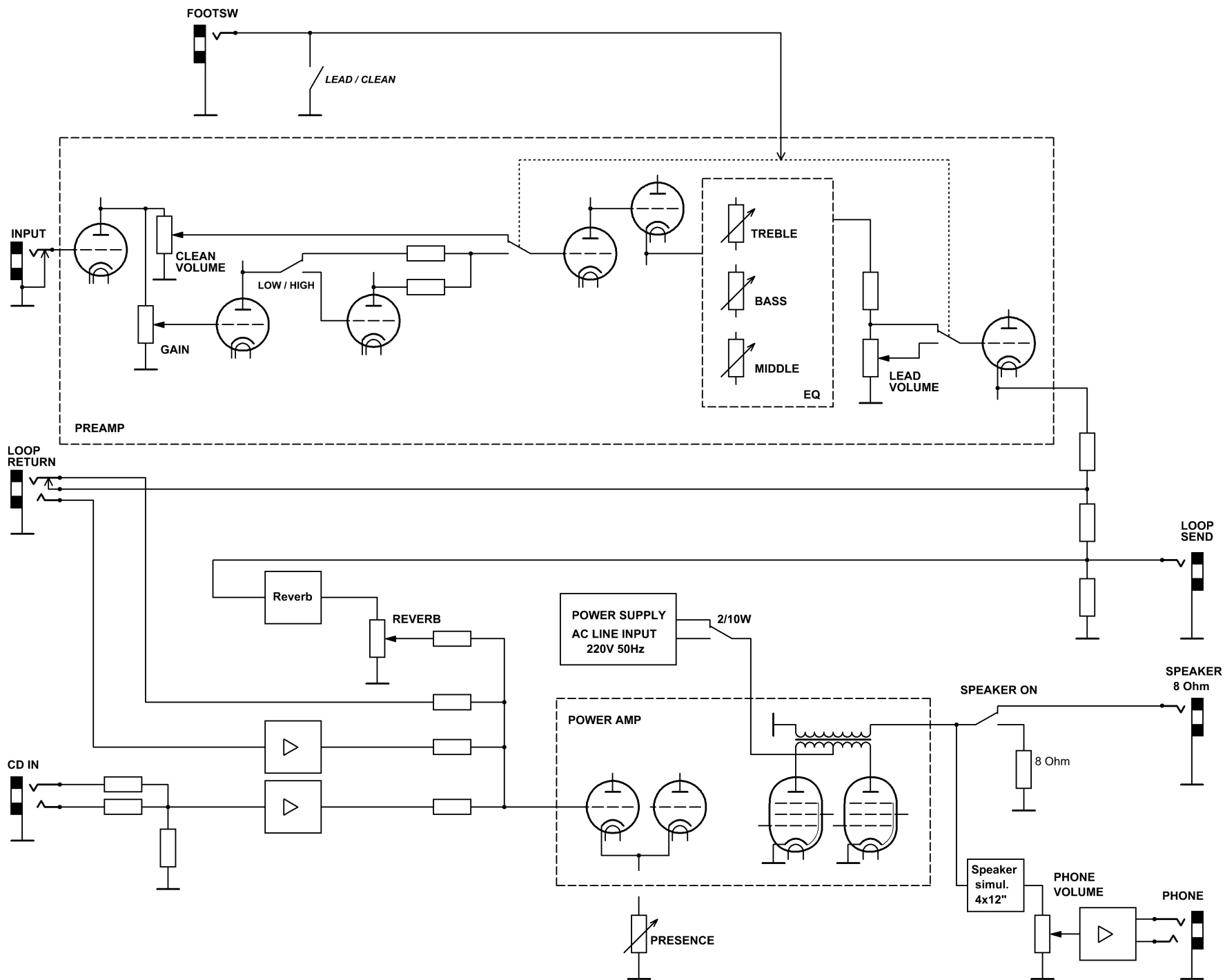

3.

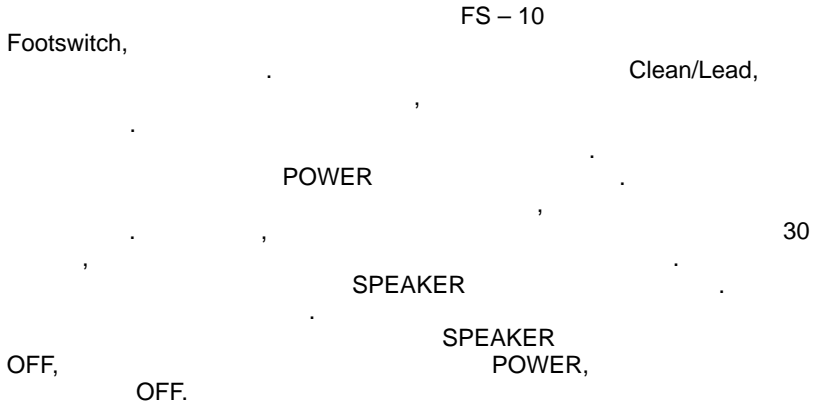

4.

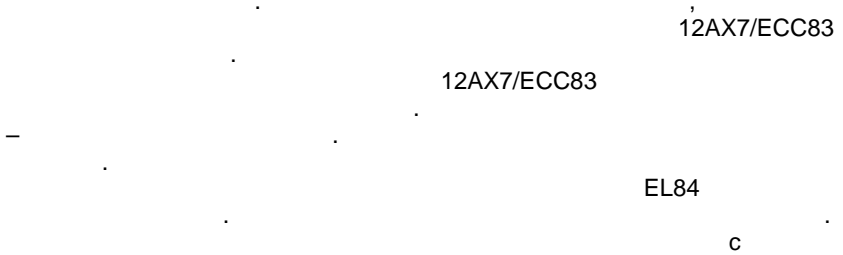

5.

	, .....	1
	, , .....	2/10
50	, .....	230±22
	, , .....	80
	, , .....	390 387 275
( )	, .....	15
	.....3x12 7/ECC83, 1x12AT7/ECC81, 2xEL84	
	: .....	Celestion G10 Vintage

6.

-	Gavrosh 10, .....	1
,	.....	1
	FS-10, .....	1
	T1A, .....	1
	, .....	1
,	.....	1

7.

:

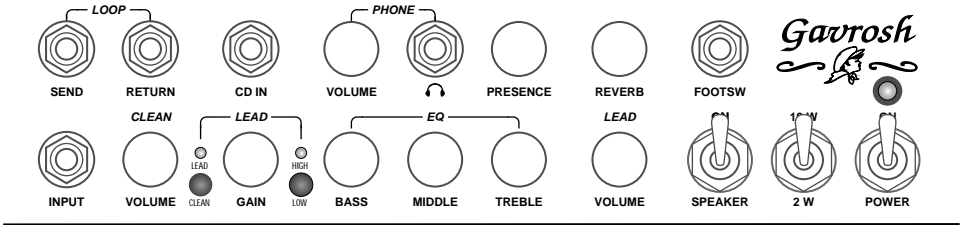

:

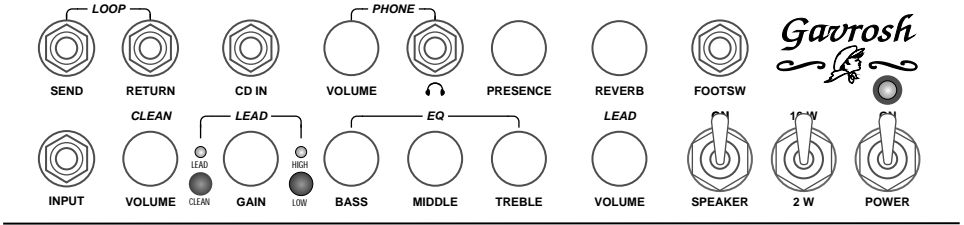

:

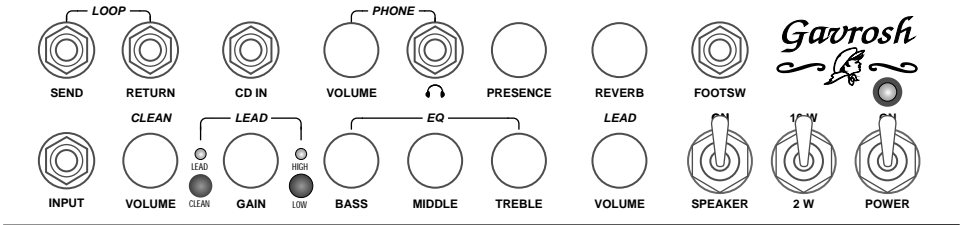

:

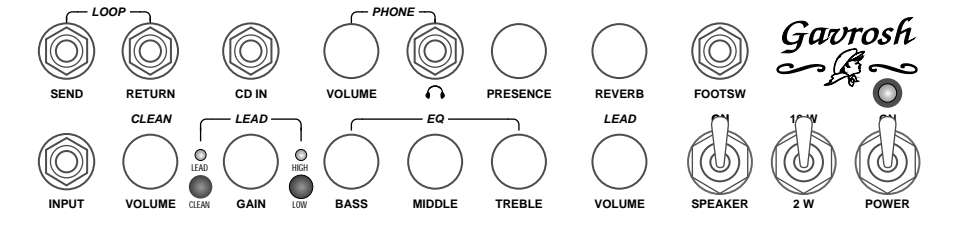

8.

12

\*

!

:

1

Gavrosh 10.....

Gavrosh 10.....

60065, 22505,  
51515, 51317.3.2-2006  
( . . 6,7), 51317.3.3,  
RU. 02. 05121

YERASOV MUSIC CORPORATION  
440003, / . (8412) 93-03-56, 93-03-60. 20.  
**WWW.YERASOV.RU**

YERASOV MUSIC CORPORATION  
440003,  
/ . (8412) 93-03-56, 93-03-60.  
E-mail: sale@yerasov.ru

20.

**YERASOV MUSIC CORPORATION**  
**[www.yerasov.ru](http://www.yerasov.ru) e-mail: [sale@yerasov.ru](mailto:sale@yerasov.ru)**